





**"The Best Defense  
is a good Offense"**

**15 BARRELS  
GRENADE LAUNCHER**



COLOR

-  RAL 1000
-  RAL 6003
-  RAL 5002
-  RAL 9010
-  RAL 9005

# LA-ML15 GRENADE LAUNCHER

## Grenade Launcher for Suppression and Riot Control

- Type:** Fully Automatic Grenade Launcher designed for suppression and riot control missions.
- Targeting System:** Features optional color night vision and infrared (IR) movement detection to monitor and engage in low-visibility conditions.
- Non-Lethal Ammunition:** Compatible with a range of non-lethal ammunition options, including standard tear gas, rubber bullets, and flashbangs, to safely disperse crowds and neutralize threats.
- Precision Targeting:** Advanced targeting system allows for accurate delivery of non-lethal munitions, minimizing the risk to civilians and ensuring mission success.
- Automatic Fire Control:** Automated firing capabilities facilitate rapid response in dynamic crowd control situations.

## Smoke Launcher System for Mission Support

- Operational Role:** Provides tactical support for missions involving crowd management and riot control.
- Defensive Maneuver:** Deploys smoke cartridges to create a visual barrier, enabling strategic retreats or advances without escalation.
- Cover for Forces:** Offers concealment for maneuvering support forces into position during peacekeeping operations.
- Battery :** 2 Hours Operational Battery and 60 times firing.

- Protection After Engagement:** Used after non-lethal engagements to prevent targeting of security forces during repositioning.
- Asset Safety:** Ensures the safety of valuable tactical vehicles during operations involving large gatherings.

- Command Vehicle Utility:** Supports command post vehicles in maintaining operational control and safety during public order events.

Specification	Value	Unit
Operating Voltage	10.5-14 18-32	VDC
Firing Range	Short (Low Velocity)	20-150 meters
	Long (High Velocity)*	150-800 meters
Ammunition Capacity	15	Pieces
Shooting Option	Single Fire	Pieces
	Triple Fire	
	Quintuple Fire	
	All Fire	
Operating Temperature	-32 / +55	°C
Body	Aluminum Anodized Body- 10 years corrosion warranty	
Firing Pin / System Warranty	10.000 Times shooting / 2 Years	
System Components	Remote Controller, Launcher, Harness	
Length	155 ±5	Milimeters
Height	380±5	Milimeters
Width	722±5	Milimeters
Barrel Length	200±5	Milimeters
Overall Weight(Max.)	38±2	Kilograms
Camera	Full Hd Color Infrared Camera	
MIL-SPEC Standards	EMI/EMC : MIL-STD-461G	
	EMI/EMC : MIL-STD-1275E	
	Environmental : MIL-STD-810H	

\*High Velocity rifled barrels are optional and weight and length of the unit is changing. Please contact with us to have more information



**LA-ML15**  
Grenade Launcher with optional colored night vision

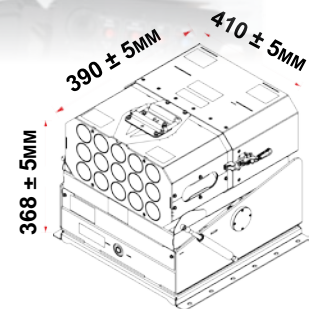

**Range is : ±45°**  
Horizontal Angle  
0-120° Vertical Angle  
10 meters to 150 meters range

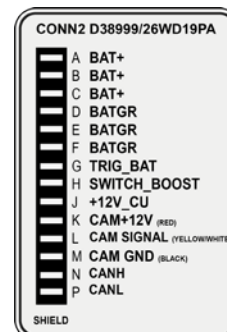
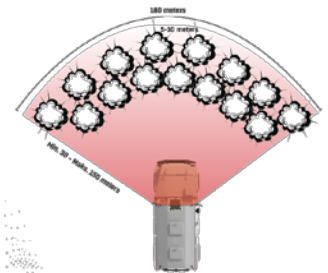

**MILITARY STANDARTS**

**MIL-STD 810**

**MIL-STD 461**

**MIL-STD 1275**