

**NERO**  
**INDUSTRIES**  
Advanced Reliability

**ARMA**  
**POWER SOLUTIONS**





# OUR FACTORIES

NERO Endüstri Savunma Sanayi A.Ş. which operates in United States of America, Bulgaria and Turkey at Ankara headquarters, is one of the largest subsystem manufacturers in Defence Industry in Turkey. Our company which is located on a plot of 12.000 m2 in Anatolia Organized Industrial Zone; has been performing hundred percent domestic design, manufacture and provide system solutions since its foundation in 2009. More than 100 engineers are assigned within its staff of 210 people. Besides, it imports 29 different countries in the world. While our group companies operate in Space Aviation field, Defence Industry, it also comprises one of the largest test centres of Turkey regarding Defence Industry



# NERO INDUSTRIES

Advanced Reliability



By combining design, production, monitoring, control and improvement methods conforming to ISO9001 and AS9100 standards with quality engineering and test infrastructure, it successfully competes with its global competitors and accomplishes outstanding projects together with world leaders of the sector.

Nero Industry has started project designing phase of the factory for the project which is worth 1.6 billion TL together with project-based investment incentive support on Presidential decree published in official gazette on 20th April, 2020 in order to establish Turkey's first semiconductor production factory. Turkey's first semiconductor serial production facility which will be established on 300.000 m2 plot, will bring our country to the level where we will be able to compete with semiconductor companies at global level. Nero Industry, together with its high qualified employees will create first investment phase of Turkey in this field with this project.

Within the scope of designed and qualified systems,

ARES - Fire Suppression Systems,

MARS - CBRN Detection and Filtration Systems,

ARMA - Power Systems,

UMAY - Laser Detection/Warning and Smoke Grenade Launcher Systems are included.

# 29

## NERO INDUSTRY SYSTEMS IMPORT TO 29 COUNTRIES

- Germany
- France
- Israel
- Spain
- Ukraine
- England
- Brasil
- Peru
- USA
- Suadi Arabia
- Azerbaijan
- Turkmenistan
- Bahrain
- United Arab Emirates
- China
- Canada
- Indonesia
- India
- Koweit
- Thailand
- Malaysia
- Kazakstan
- Oman
- Latvia
- Pakistan
- Esthonia
- Katar
- Lithuania
- Singapore



# ARMA POWER SYSTEMS

All military vehicles and military platforms need extra power to keep their systems active, apart from the power produced by the vehicle. These powers are provided by a different power generating system or from the grid electricity at the location of the vehicle. Some platforms need such high power that they have to use all the power generating systems they have.

**Nero Industry Arma Power Systems** provides Military Generator, APU, PTO Alternator and AC/DC Converter (rectifier) systems for military vehicles and military platforms to provide the power needed by the platform and the capability systems on the vehicle. These systems provide the military vehicle with extra power as AC - DC in the required feature and volume. Thanks to this power, the military platform; It achieves capabilities such as silent operation capability and high reliability rate on the vehicle platform.

At the same time, there are dozens of systems on the vehicle, but the power generating systems are on average 4-5. There are power units in order for the systems to distribute and control these power needs automatically and to receive the errors and feedbacks that occur in the system and deliver them to the user via ethernet and remote connection. These power distribution units are systems that automatically distribute and control the power produced by the platforms on the vehicle as needed by the platform and systems. These smart power solutions are fully qualified systems that have passed the MIL-STD-810G, MIL-STD-461E tests and can operate in all harsh environmental conditions.



# GENERATOR FAMILY



Page-8  
3 KVA - G3M



Page-11  
15KVA - G15M



Page-17  
25 KVA - G25MC



Page-19  
28KVA - G28M

# APU FAMILY



Page-28  
APU - A151K



Page-29  
APU - A12011



Page-34  
NL-1628 Control Unit



Page-36  
A20-F Control Unit

# POWER DISTRIBUTION UNITS



Page-37  
Equipment Container Shelter



Page-39  
GDU 336 Power Dist. Unit



Page-41  
PDU 80 Power Dist. Unit



Page-43  
PDU70 Power Dist. Unit

# PTO, MANAGEMENT AND DISTRIBUTION UNITS



Page-45  
PTO P40 Alternator



Page-45  
PTO P50 Alternator



Page-47  
AC/DC Converter

# ARMA POWER SYSTEMS SUBPRODUCT CATEGORY GENERAL SPECIFICATIONS

2-1000 kW  
Power  
Capacity

Smart  
Control  
Units

Super  
Silent and  
Compact  
Design

24 Hours  
Continu-  
ous Power



100% Re-  
liability at  
Extreme  
Circum-  
stances

Dual-  
Mobile-  
Platform

Remote  
Access

High  
Efficiency

Tailor-  
Made  
Design



# MILITARY GENERATOR GENERAL CAPABILITIES

MIL-STD-1275E conformant  
MIL-STD-810G tests completed  
MIL-STD-461 EMI tests completed

It can be designed  
and applied as Dual –  
Mobile – Platform

Specially developed electronic  
cards and control unit instead of  
electronic board panel to reduce  
weight and dimensions 30%

Ability to operate at  
55oC without overheat

Silent : 55 db at 7  
meters

Capability to develop  
military generators  
between 2KW and  
1000KW

Design for special  
dimensions







# MILITARY GENERATOR 3 KVA - G3M

## TECHNICAL SPECIFICATIONS

**GENERATOR TYPE**  
Mobile Generator

**STAND BY POWER**  
3 KVA

**CONTINUOUS POWER**  
2,5 KVA

**FREQUENCY**  
50 Hz

**COOLING SYSTEM**  
Water Cooling System

**VOLTAGE PHASE NUMBER**  
1

**CONNECTION TYPE**  
RS422 - TCP

**SOUND LEVEL**  
75 Db in 7 Meters

**WEIGHT**  
156 KG

**OPERATING TEMPERATURE**  
-32 / +55 °C

**STORAGE TEMPERATURE**  
-40 / +60 °C

**FUEL TYPE - CONSUMPTION**  
Diesel - 3 LT/H

**BATTERY CAPACITY**  
40 AH

**DIMENSIONS (L x W x H)**  
882×525×603 ±5 mm

## ENGINE SPECIFICATIONS

<b>ENGINE</b>	Kubota
<b>MODEL</b>	Z482
<b>OUTPUT POWER</b>	9,3 kW
<b>ENGINE TYPE</b>	Water Cooling Vertical Diesel Engine
<b>NUMBER OF CYLINDERS</b>	2
<b>MAXIMUM SPEED</b>	3000 RPM
<b>STARTING SYSTEM</b>	Electrical Starting System

## ALTERNATOR SPECIFICATIONS

<b>OUTPUT POWER</b>	7 KVA
<b>PROTECTION CLASS</b>	IP23
<b>VOLTAGE SENSITIVITY</b>	± 2% V
<b>MAXIMUM SPEED</b>	3000 RPM

## MILITARY STANDARDS

<b>MIL-STD-461F</b>	<b>MIL-STD-810G</b>
<b>High Temperature</b>	<b>Low Temperature</b>
<b>Humidity Test</b>	<b>Vibration Test</b>

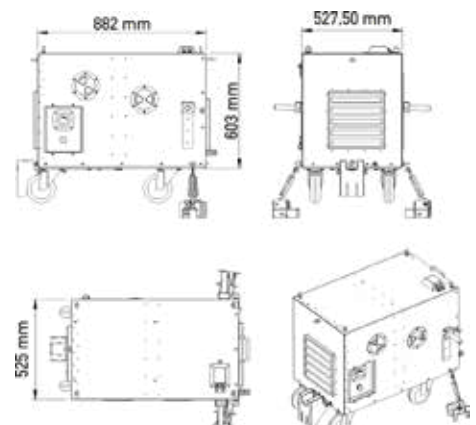



# MILITARY GENERATOR 5 KVA - G5M

## TECHNICAL SPECIFICATIONS



**GENERATOR TYPE**  
Mobile Generator



**VOLTAGE PHASE NUMBER**  
1



**STORAGE TEMPERATURE**  
-40 / +60 °C



**STAND BY POWER**  
5 KVA



**CONNECTION TYPE**  
CANBUS/Serial/Ethernet



**FUEL TYPE - CONSUMPTION**  
Diesel - 3 LT/H



**CONTINUOUS POWER**  
4 KVA



**SOUND LEVEL**  
95 Db in 7 Meters



**BATTERY CAPACITY**  
40 AH



**FREQUENCY**  
50 Hz



**WEIGHT**  
230 KG ±5



**DIMENSIONS (L x W x H)**  
922x635x917 ±5 mm



**COOLING SYSTEM**  
Water Cooling System



**OPERATING TEMPERATURE**  
-32 / +55 °C

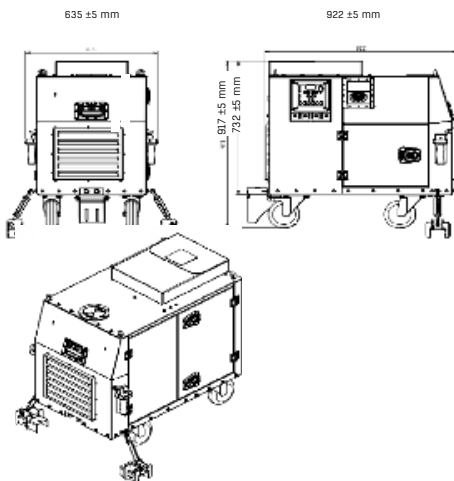

## ALTERNATOR SPECIFICATIONS

<b>OUTPUT POWER</b>	7 KVA
<b>PROTECTION CLASS</b>	IP23
<b>VOLTAGE SENSITIVITY</b>	± 2% V
<b>MAXIMUM SPEED</b>	3000 RPM

## MILITARY STANDARDS

<b>MIL-STD-461F</b>	<b>MIL-STD-810G</b>
<b>High Temperature</b>	<b>Low Temperature</b>
<b>Humidity Test</b>	<b>Vibration Test</b>

## ENGINE SPECIFICATIONS

<b>ENGINE</b>	Kubota
<b>MODEL</b>	Z482
<b>OUTPUT POWER</b>	9,3 kW
<b>ENGINE TYPE</b>	Water Cooling Vertical Diesel Engine
<b>NUMBER OF CYLINDERS</b>	2
<b>MAXIMUM SPEED</b>	3000 RPM
<b>STARTING SYSTEM</b>	Electrical Starting System



# MILITARY GENERATOR 7 KVA - G7M

## TECHNICAL SPECIFICATIONS



**GENERATOR TYPE**  
Mobile Generator



**VOLTAGE PHASE NUMBER**  
1



**STORAGE TEMPERATURE**  
-40 / +60 °C



**STAND BY POWER**  
7 KVA



**CONNECTION TYPE**  
RS422 – TCP



**FUEL TYPE - CONSUMPTION**  
Diesel - 3 LT/H



**CONTINUOUS POWER**  
4,3 KVA



**SOUND LEVEL**  
75 Db in 7 Meters



**BATTERY CAPACITY**  
70 AH @12V



**FREQUENCY**  
50 Hz



**WEIGHT**  
170 KG



**DIMENSIONS (L x W x H)**  
922×538×701 ±5 mm



**COOLING SYSTEM**  
Water Cooling System



**OPERATING TEMPERATURE**  
-32 / +55 °C

### ENGINE SPECIFICATIONS

<b>ENGINE</b>	Kubota
<b>MODEL</b>	Z482
<b>OUTPUT POWER</b>	9,3 kW
<b>ENGINE TYPE</b>	Water Cooling Vertical Diesel Engine
<b>NUMBER OF CYLINDERS</b>	2
<b>MAXIMUM SPEED</b>	3000 RPM
<b>STARTING SYSTEM</b>	Electrical Starting System

### ALTERNATOR SPECIFICATIONS

<b>OUTPUT POWER</b>	7 KVA
<b>PROTECTION CLASS</b>	IP23
<b>VOLTAGE SENSITIVITY</b>	± 2% V
<b>MAXIMUM SPEED</b>	3000 RPM

### MILITARY STANDARDS

<b>MIL-STD-461F</b>	<b>MIL-STD-810G</b>
<b>High Temperature</b>	<b>Low Temperature</b>
<b>Humidity Test</b>	<b>Vibration Test</b>

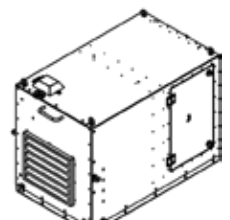
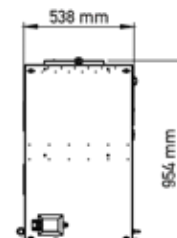
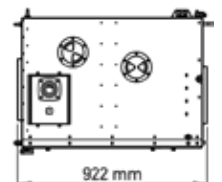
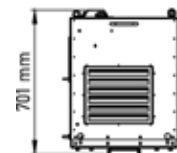



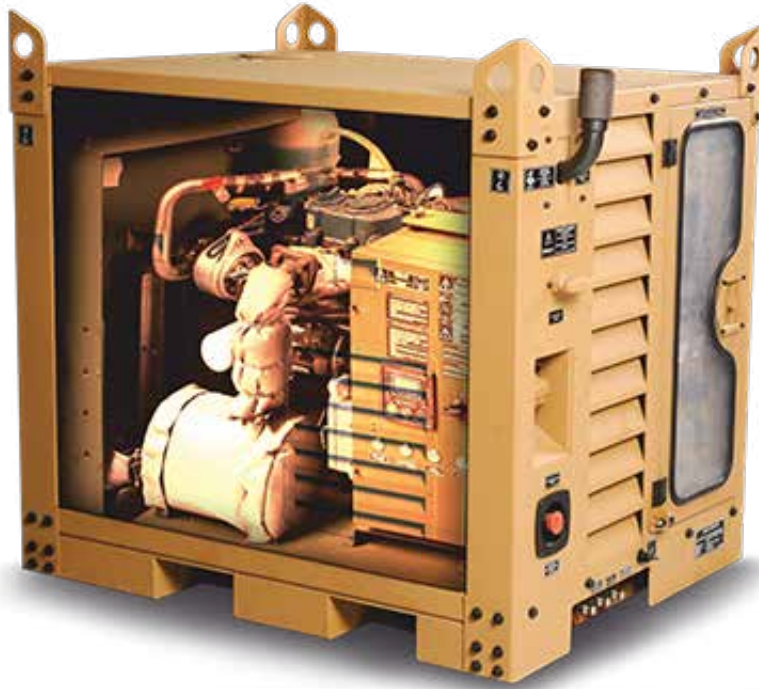

# MILITARY GENERATOR 15 KVA-G15M

## TECHNICAL SPECIFICATIONS



**GENERATOR TYPE**  
Mobile Generator



**VOLTAGE PHASE NUMBER**  
1



**STORAGE TEMPERATURE**  
-40 / +60 °C



**STAND BY POWER**  
15 KVA



**CONNECTION TYPE**  
RS422 – TCP



**FUEL TYPE - CONSUMPTION**  
Diesel - 5 LT/H



**CONTINUOUS POWER**  
12,5 KVA



**SOUND LEVEL**  
75 Db in 7 Meters



**BATTERY CAPABILITY**  
95 AH @12V



**FREQUENCY**  
50 Hz



**WEIGHT**  
700 KG ±5



**DIMENSIONS (L x W x H)**  
882x 525 x 527,50 ±5 mm



**COOLING SYSTEM**  
Water Cooling System



**OPERATING TEMPERATURE**  
-32 / +55 °C

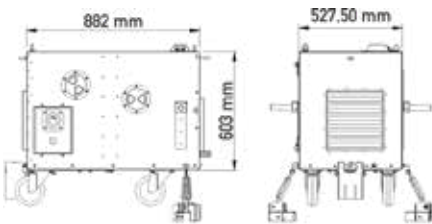

## ALTERNATOR SPECIFICATIONS

<b>OUTPUT POWER</b>	20 KVA
<b>PROTECTION CLASS</b>	IP23
<b>VOLTAGE SENSITIVITY</b>	± 2% V
<b>MAXIMUM SPEED</b>	3000 RPM

## ENGINE SPECIFICATIONS

<b>ENGINE</b>	Kubota
<b>MODEL</b>	D1105T
<b>OUTPUT POWER</b>	24,5 kW
<b>ENGINE TYPE</b>	Water Cooling Vertical Diesel Engine
<b>NUMBER OF CYLINDERS</b>	3
<b>MAXIMUM SPEED</b>	3000 RPM
<b>STARTING SYSTEM</b>	Electrical Starting System

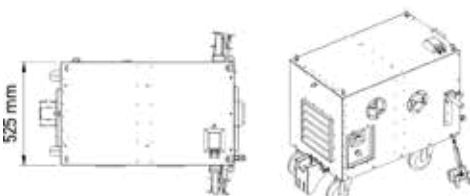

## MILITARY STANDARDS

<b>MIL-STD-461F</b>	<b>MIL-STD-810G</b>
<b>High Temperature</b>	<b>Low Temperature</b>
<b>Humidity Test</b>	<b>Vibration Test</b>



# MILITARY GENERATOR 17 KVA - G17M

## TECHNICAL SPECIFICATIONS



**GENERATOR TYPE**  
Mobile Generator



**VOLTAGE PHASE NUMBER**  
1



**STORAGE TEMPERATURE**  
-40 / +60 °C



**STAND BY POWER**  
17 KVA



**CONNECTION TYPE**  
RS422 - TCP



**FUEL TYPE - CONSUMPTION**  
Diesel - 5 LT/H



**CONTINUOUS POWER**  
12,5 KVA (10KW)



**SOUND LEVEL**  
75 Db in 7 Meters



**BATTERY CAPACITY**  
95 AH @12V



**FREQUENCY**  
50 Hz



**WEIGHT**  
863 KG ±5



**DIMENSIONS (L x W x H)**  
882x525x527,50 ±5 mm



**COOLING SYSTEM**  
Water Cooling System



**OPERATING TEMPERATURE**  
-32 / +55 °C

## ENGINE SPECIFICATIONS

<b>ENGINE</b>	Kubota
<b>MODEL</b>	D1105T
<b>OUTPUT POWER</b>	24,5 kW
<b>ENGINE TYPE</b>	Water Cooling Vertical Diesel Engine
<b>NUMBER OF CYLINDERS</b>	3
<b>MAXIMUM SPEED</b>	3000 RPM
<b>STARTING SYSTEM</b>	Electrical Starting System

## ALTERNATOR SPECIFICATIONS

<b>OUTPUT POWER</b>	17 KVA
<b>PROTECTION CLASS</b>	IP23
<b>VOLTAGE SENSITIVITY</b>	± 2% V
<b>MAXIMUM SPEED</b>	3000 RPM

## MILITARY STANDARDS

<b>MIL-STD-461F</b>	<b>MIL-STD-810G</b>
<b>High Temperature</b>	<b>Low Temperature</b>
<b>Humidity Test</b>	<b>Vibration Test</b>

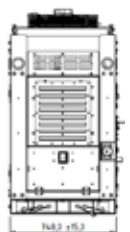
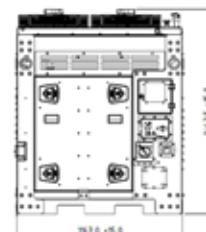
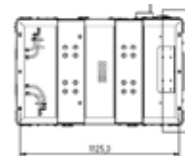



# MILITARY GENERATOR 20 KVA - G20M

## TECHNICAL SPECIFICATIONS



**GENERATOR TYPE**  
H class



**VOLTAGE PHASE NUMBER**  
3



**STORAGE TEMPERATURE**  
-40 / +60 °C



**STAND BY POWER**  
22,5 KVA



**CONNECTION TYPE**  
RS422 – TCP



**FUEL TYPE - CONSUMPTION**  
Diesel - 8,6 LT/H



**CONTINUOUS POWER**  
20 KVA



**SOUND LEVEL**  
70 Db in 7 Meters



**BATTERY CAPACITY**  
95 AH @12V



**FREQUENCY**  
50 Hz



**WEIGHT**  
900 KG ±5



**DIMENSIONS (L x W x H)**  
1484x1318x791 ±5 mm



**COOLING SYSTEM**  
Water Cooling System



**OPERATING TEMPERATURE**  
-32 / +55 °C

## ALTERNATOR SPECIFICATIONS

<b>OUTPUT POWER</b>	24,5 KVA
<b>PROTECTION CLASS</b>	IP23
<b>VOLTAGE SENSITIVITY</b>	± 2,5 % V
<b>MAXIMUM SPEED</b>	3000 RPM

## MILITARY STANDARDS

<b>MIL-STD-461F</b>	<b>MIL-STD-810G</b>
<b>High Temperature</b>	<b>Low Temperature</b>
<b>Humidity Test</b>	<b>Vibration Test</b>

## ENGINE SPECIFICATIONS

<b>ENGINE</b>	Perkins
<b>MODEL</b>	404D-22G
<b>OUTPUT POWER</b>	33 kW
<b>ENGINE TYPE</b>	Water Cooling Vertical Diesel Engine
<b>NUMBER OF CYLINDERS</b>	4
<b>MAXIMUM SPEED</b>	1500 RPM
<b>STARTING SYSTEM</b>	Electrical Starting System

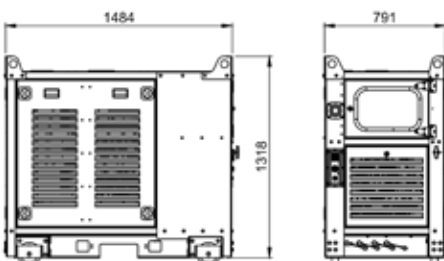





# MILITARY GENERATOR 22,5 KVA - G22D

## TECHNICAL SPECIFICATIONS



**GENERATOR TYPE**  
Platform/Ray/Dual



**VOLTAGE PHASE NUMBER**  
3



**STORAGE TEMPERATURE**  
-40 / +60 °C



**STAND BY POWER**  
22,5 KVA



**CONNECTION TYPE**  
RS422 – TCP/ IP-CANBUS



**FUEL TYPE - CONSUMPTION**  
Diesel - 8,6 LT/H



**CONTINUOUS POWER**  
18,5 KVA



**SOUND LEVEL**  
75 Db in 7 Meters



**BATTERY CAPACITY**  
95 AH @12V



**FREQUENCY**  
50 Hz



**WEIGHT**  
1000 KG ±5



**DIMENSIONS (L x W x H)**  
2456×678×1734 ±5 mm



**COOLING SYSTEM**  
Water Cooling System



**OPERATING TEMPERATURE**  
-32 / +55 °C

## ENGINE SPECIFICATIONS

<b>ENGINE</b>	Kubota
<b>MODEL</b>	V1505T
<b>OUTPUT POWER</b>	9,3 kW
<b>ENGINE TYPE</b>	Water Cooling Vertical Diesel Engine
<b>NUMBER OF CYLINDERS</b>	4
<b>MAXIMUM SPEED</b>	3000 RPM
<b>STARTING SYSTEM</b>	Electrical Starting System

## ALTERNATOR SPECIFICATIONS

<b>OUTPUT POWER</b>	33 KVA
<b>PROTECTION CLASS</b>	IP23
<b>VOLTAGE SENSITIVITY</b>	± 2% V
<b>MAXIMUM SPEED</b>	3000 RPM

## MILITARY STANDARDS

<b>MIL-STD-461F</b>	<b>MIL-STD-810G</b>
<b>High Temperature</b>	<b>Low Temperature</b>
<b>Humidity Test</b>	<b>Vibration Test</b>

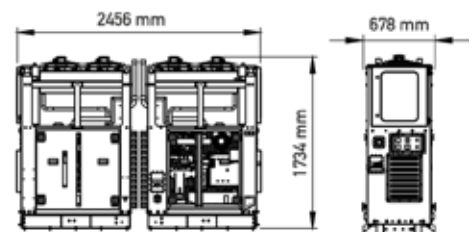
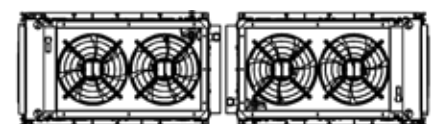



# MILITARY GENERATOR 25 KVA - G25DM

## TECHNICAL SPECIFICATIONS

 **GENERATOR TYPE**  
Platform/Ray/Dual/Senkron

 **VOLTAGE PHASE NUMBER**  
3

 **STORAGE TEMPERATURE**  
-40 / +60 °C

 **STAND BY POWER**  
25 KVA

 **CONNECTION TYPE**  
RS422 – TCP/ IP-CANBUS

 **FUEL TYPE - CONSUMPTION**  
Diesel - 6,1 LT/H

 **CONTINUOUS POWER**  
20 KVA

 **SOUND LEVEL**  
75 Db in 7 Meters

 **BATTERY CAPACITY**  
95 AH @12V

 **FREQUENCY**  
50 Hz

 **WEIGHT**  
800 KG ±5

 **DIMENSIONS (L x W x H)**  
1655×793×1318 ±5 mm

 **COOLING SYSTEM**  
Water Cooling System

 **OPERATING TEMPERATURE**  
-32 / +55 °C

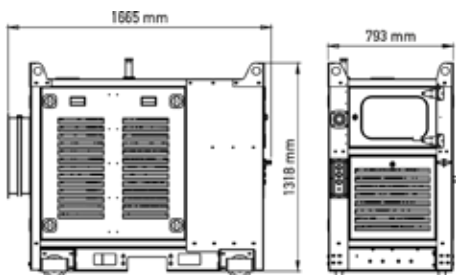

## ALTERNATOR SPECIFICATIONS

<b>OUTPUT POWER</b>	25 KVA
<b>PROTECTION CLASS</b>	IP23
<b>VOLTAGE SENSITIVITY</b>	± 2,5 % V
<b>MAXIMUM SPEED</b>	1500 RPM

## MILITARY STANDARDS

<b>MIL-STD-461F</b>	<b>MIL-STD-810G</b>
<b>High Temperature</b>	<b>Low Temperature</b>
<b>Humidity Test</b>	<b>Vibration Test</b>

## ENGINE SPECIFICATIONS

<b>ENGINE</b>	Perkins
<b>MODEL</b>	404D22G
<b>OUTPUT POWER</b>	30 kW
<b>ENGINE TYPE</b>	Water Cooling Vertical Diesel Engine
<b>NUMBER OF CYLINDERS</b>	4
<b>MAXIMUM SPEED</b>	1500 RPM
<b>STARTING SYSTEM</b>	Electrical Starting System



# MILITARY GENERATOR 25 KVA - G25M

## TECHNICAL SPECIFICATIONS



**GENERATOR TYPE**  
Platform / Senkron



**VOLTAGE PHASE NUMBER**  
3



**STORAGE TEMPERATURE**  
-40 / +60 °C



**STAND BY POWER**  
25 KVA



**CONNECTION TYPE**  
RS422 - TCP/ IP-CANBUS



**FUEL TYPE - CONSUMPTION**  
Diesel - 8,6 LT/H



**CONTINUOUS POWER**  
20 KVA



**SOUND LEVEL**  
7 Metrede 64 dB



**BATTERY CAPACITY**  
95 AH @24V



**FREQUENCY**  
50 Hz



**WEIGHT**  
860 KG ±5



**DIMENSIONS (L x W x H)**  
1907×600×1406 ±5 mm



**COOLING SYSTEM**  
Water Cooling System



**OPERATING TEMPERATURE**  
-32 / +55 °C

## ENGINE SPECIFICATIONS

<b>ENGINE</b>	Perkins
<b>MODEL</b>	404D-22TG
<b>OUTPUT POWER</b>	36 kW
<b>ENGINE TYPE</b>	Water Cooling Vertical Diesel Engine
<b>NUMBER OF CYLINDERS</b>	4
<b>MAXIMUM SPEED</b>	3000 RPM
<b>STARTING SYSTEM</b>	Electrical Starting System

## ALTERNATOR SPECIFICATIONS

<b>OUTPUT POWER</b>	30 KVA
<b>PROTECTION CLASS</b>	IP23
<b>VOLTAGE SENSITIVITY</b>	± 2,5 % V
<b>MAXIMUM SPEED</b>	1500 RPM

## MILITARY STANDARDS

<b>MIL-STD-461F</b>	<b>MIL-STD-810G</b>
<b>High Temperature</b>	<b>Low Temperature</b>
<b>Humidity Test</b>	<b>Vibration Test</b>

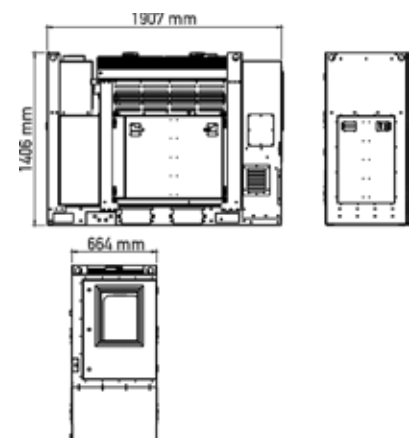





# MILITARY GENERATOR 25 KVA - G25MC

## TECHNICAL SPECIFICATIONS



**GENERATOR TYPE**  
Platform / Senkron



**STAND BY POWER**  
25 KVA



**CONTINUOUS POWER**  
22,5 KVA



**FREQUENCY**  
50 Hz



**COOLING SYSTEM**  
Water Cooling System



**VOLTAGE PHASE NUMBER**  
3



**CONNECTION TYPE**  
RS422 - TCP/ IP-CANBUS



**SOUND LEVEL**  
64 Db in 7 Meters



**WEIGHT**  
1000 KG ±5



**OPERATING TEMPERATURE**  
-32 / +55 °C



**STORAGE TEMPERATURE**  
-40 / +60 °C



**FUEL TYPE - CONSUMPTION**  
Diesel - 8,6 LT/H



**BATTERY CAPABILITY**  
120 AH @24V



**DIMENSIONS (L x W x H)**  
1907×600×1406 ±5 mm

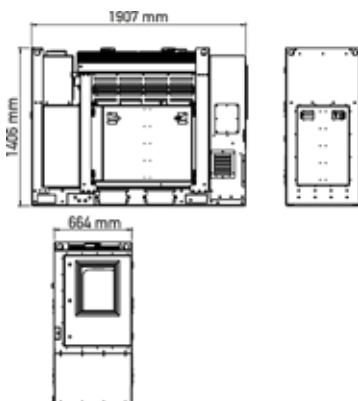

## ALTERNATOR SPECIFICATIONS

<b>OUTPUT POWER</b>	28,8 KVA
<b>PROTECTION CLASS</b>	IP23
<b>VOLTAGE SENSITIVITY</b>	± 2,5 % V
<b>MAXIMUM SPEED</b>	3000 RPM

## MILITARY STANDARDS

<b>MIL-STD-461F</b>	<b>MIL-STD-810G</b>
<b>High Temperature</b>	<b>Low Temperature</b>
<b>Humidity Test</b>	<b>Vibration Test</b>

## ENGINE SPECIFICATIONS

<b>ENGINE</b>	Kubota
<b>MODEL</b>	V1505T
<b>OUTPUT POWER</b>	33 kW
<b>ENGINE TYPE</b>	Water Cooling Vertical Diesel Engine
<b>NUMBER OF CYLINDERS</b>	4
<b>MAXIMUM SPEED</b>	3000 RPM
<b>STARTING SYSTEM</b>	Electrical Starting System



# MILITARY GENERATOR 25 KVA - G255

## TECHNICAL SPECIFICATIONS



**GENERATOR TYPE**  
Platform/ Senkron



**VOLTAGE PHASE NUMBER**  
3



**STORAGE TEMPERATURE**  
-40 / +60 °C



**STAND BY POWER**  
25 KVA



**CONNECTION TYPE**  
RS422 - TCP/ IP-CANBUS



**YAKIT TYPE /TÜKETİMİ**  
Diesel - 6,1 LT/H



**CONTINUOUS POWER**  
22,5 KVA



**SOUND LEVEL**  
64 Db in 7 Meters



**BATTERY CAPABILITY**  
120 AH @24V



**FREQUENCY**  
50 Hz



**WEIGHT**  
1000 KG ±5



**DIMENSIONS (L x W x H)**  
2000×600×1107 ±5 mm



**COOLING SYSTEM**  
Water Cooling System



**OPERATING TEMPERATURE**  
-32 / +55 °C

## ENGINE SPECIFICATIONS

<b>ENGINE</b>	Kubota
<b>MODEL</b>	V1505T
<b>OUTPUT POWER</b>	33 kW
<b>ENGINE TYPE</b>	Water Cooling Vertical Diesel Engine
<b>NUMBER OF CYLINDERS</b>	4
<b>MAXIMUM SPEED</b>	3000 RPM
<b>STARTING SYSTEM</b>	Electrical Starting System

## ALTERNATOR SPECIFICATIONS

<b>OUTPUT POWER</b>	28,8 KVA
<b>PROTECTION CLASS</b>	IP23
<b>VOLTAGE SENSITIVITY</b>	± 2,5 % V
<b>MAXIMUM SPEED</b>	3000 RPM

## MILITARY STANDARDS

<b>MIL-STD-461F</b>	<b>MIL-STD-810G</b>
<b>High Temperature</b>	<b>Low Temperature</b>
<b>Humidity Test</b>	<b>Vibration Test</b>

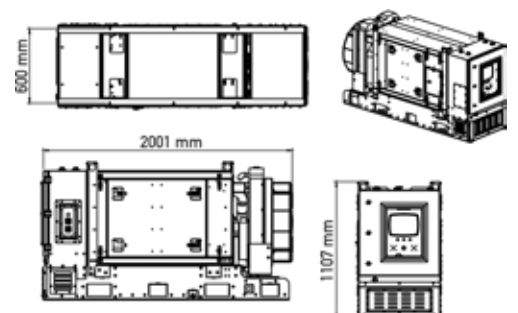



# MILITARY GENERATOR 28 KVA - G28M

## TECHNICAL SPECIFICATIONS



**GENERATOR TYPE**  
Platform/Ray



**VOLTAGE PHASE NUMBER**  
3



**STORAGE TEMPERATURE**  
-40 / +60 °C



**STAND BY POWER**  
28,8 KVA



**CONNECTION TYPE**  
RS422 – RS485



**FUEL TYPE - CONSUMPTION**  
Diesel - 7,8 LT/H



**CONTINUOUS POWER**  
22,5 KVA



**SOUND LEVEL**  
70 Db in 7 Meters



**BATTERY CAPABILITY**  
95 AH @24V



**FREQUENCY**  
50 Hz



**WEIGHT**  
1000 KG ±5



**DIMENSIONS (L x W x H)**  
1195x800x1620 ±5 mm



**COOLING SYSTEM**  
Water Cooling System



**OPERATING TEMPERATURE**  
-32 / +55 °C

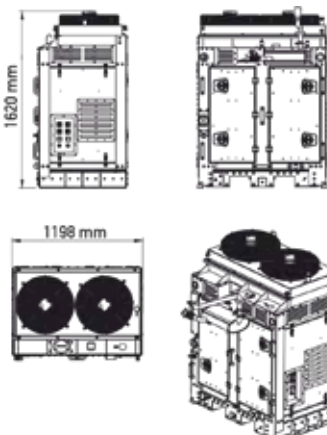

## ALTERNATOR SPECIFICATIONS

<b>OUTPUT POWER</b>	28,8 KVA
<b>PROTECTION CLASS</b>	IP23
<b>VOLTAGE SENSITIVITY</b>	± 2,5 % V
<b>MAXIMUM SPEED</b>	3000 RPM

## MILITARY STANDARDS

<b>MIL-STD-461F</b>	<b>MIL-STD-810G</b>
High Temperature	Low Temperature
Humidity Test	Vibration Test

## ENGINE SPECIFICATIONS

<b>ENGINE</b>	Kubota
<b>MODEL</b>	V1505T
<b>OUTPUT POWER</b>	33 kW
<b>ENGINE TYPE</b>	Water Cooling Vertical Diesel Engine
<b>NUMBER OF CYLINDERS</b>	4
<b>MAXIMUM SPEED</b>	3000 RPM
<b>STARTING SYSTEM</b>	Electrical Starting System





# MILITARY GENERATOR 80 KVA-G80S

## TECHNICAL SPECIFICATIONS



**GENERATOR TYPE**  
Platform / Senkron



**VOLTAGE PHASE NUMBER**  
3



**STORAGE TEMPERATURE**  
-40 / +60 °C



**STAND BY POWER**  
80 KVA



**CONNECTION TYPE**  
RS422 – TCP



**FUEL TYPE - CONSUMPTION**  
Diesel - 10 LT/H



**CONTINUOUS POWER**  
62,5 KVA



**SOUND LEVEL**  
70 Db in 7 Meters



**BATTERY CAPABILITY**  
120 AH @24V



**FREQUENCY**  
50 Hz



**WEIGHT**  
2000 KG ±5



**DIMENSIONS ( L x W x H )**  
1484x1318x791 ±5 mm



**COOLING SYSTEM**  
Water Cooling System



**OPERATING TEMPERATURE**  
-32 / +55 °C

## ENGINE SPECIFICATIONS

<b>ENGINE</b>	Perkins
<b>MODEL</b>	1104C-44TAG2
<b>OUTPUT POWER</b>	33 kW
<b>ENGINE TYPE</b>	Water Cooling Vertical Diesel Engine
<b>NUMBER OF CYLINDERS</b>	4
<b>MAXIMUM SPEED</b>	1500 RPM
<b>STARTING SYSTEM</b>	Electrical Starting System

## ALTERNATOR SPECIFICATIONS

<b>OUTPUT POWER</b>	110 KVA
<b>PROTECTION CLASS</b>	IP23
<b>VOLTAGE SENSITIVITY</b>	± 2,5 % V
<b>MAXIMUM SPEED</b>	1500 RPM

## MILITARY STANDARDS

<b>MIL-STD-461F</b>	<b>MIL-STD-810G</b>
<b>High Temperature</b>	<b>Low Temperature</b>
<b>Humidity Test</b>	<b>Vibration Test</b>

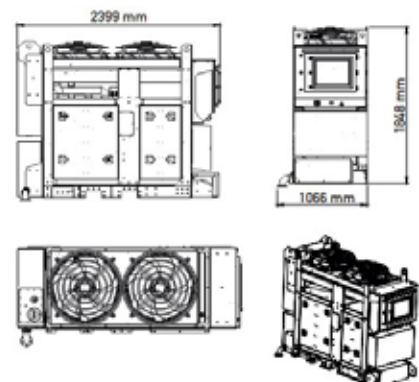

# A2304 GENERATOR CONTROL UNIT (SINGLE SYSTEM)



- It is positioned on the generator so that user can easily interfere in case of maintenance.
- It shows existing error and health status of the generator.
- It has 95% BIT capability.
- It is designed as per IP67 Standards. It also provides the opportunity to reach last 500 detailed log thanks to diagnostic.
- It enables to operate in 9-36 volts range.
- The signals transferred only with connectors, there is no need for panel.
- It is conformant to MIL-STD-810G and MIL-STD-461E/F standards.

Dimensions (Widthx-lengthxheight)	140x213x160 ±5 mm	Weight	3,1 kg ±0.1	Communication Protocol	CANBUS J1939 - RS485 - RS422
-----------------------------------	-------------------	--------	-------------	------------------------	------------------------------

# NR-200 GENERATOR CONTROL UNIT (DUAL AND SENKRON SYSTEM)



- Easy switching between grid or multi-generator applications
- Connection of multiple generators in parallel with the existing grid together with the Intelicontroller 210 controller
- Two types of synchronization: Phase match or shift synchronization
- Isochronous (CAN) or Droop, load sharing including emergency drop
- Direct communication with EFI engines, including Tier 4 Final support

## COMMUNICATION AND CONNECTION CAPABILITIES

» USB, CAN and RS485
» USB master for configuration or firmware upload or download
» RS232 and additional RS485 with add-on module
» Internet access using Ethernet, GPRS/3G/4G with plug-in modules
» Configurable Modbus RTU or TCP and SNMP protocols v2 support
» Built-in PLC support with PLC editor and monitor including InteliConfig
» Active SMS and emails in different languages
» Geofencing and monitoring via WebSupervisor

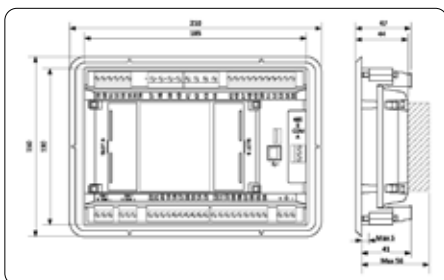

# A3008 GENERATOR CONTROL UNIT (SINGLE SYSTEM)



- It is positioned on the generator so that user can easily interfere in case of maintenance.
- It shows existing error and health status of the generator.
- It has 95% BIT capability.
- It is designed as per IP67 Standards. It also provides the opportunity to reach last 500 detailed log thanks to diagnostic.
- It enables to operate in 9-36 volts range.
- The signals transferred only with connectors, there is no need for panel.
- It is conformant to MIL-STD-810G and MIL-STD-461E/F standards.

## TECHNICAL SPECIFICATIONS

Dimensions (Widthx-lengthxheight)	83x161x212+5 mm
Weight	0,9 kg+0.1
Communication Protocol	CANBUS J1939 – RS485 – RS422
Operation Voltage	9-36V DC

## ERROR LEDS

• AC Over Current
• General Error
• Low Fuel Level
• Radiator No Water
• Engine High Temperature
• Engine Low Oil Pressure

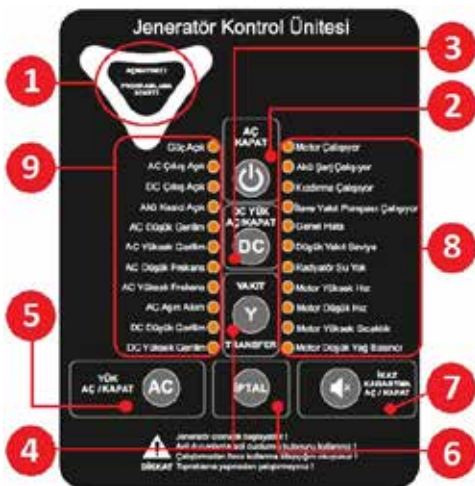

## BUTTON SPECIFICATIONS

1. Programming Socket	6. Cancel
2. Generator On/Off	7. Warning Dimming On/Off
3. DC Load On/Off	8. Right Led Warnings
4. Fuel Transfer	9. Left Led Warnings
5. AC Load On/Off	

# N10 TRANSFER PANEL



- While there is electricity in the grid, loads are fed from the active grid. However, when the grid electricity is interrupted or reduced, the generator is activated and continues to feed the load. After the electric current returns to its normal course, this energy is transferred back to the grid and the generator is deactivated. The element that performs this transfer is defined as the transfer board.
- **N10 Transfer Panel**, developed by Nero Industry, is a system that directs the energy coming from the generator based on the load output and enables the energy to be switched. By opening the grid contacts, it prevents the overlapping of 2 powers. With this system, mains and generator energy are controlled by switches and transferred safely.
- The N10 Transfer Board is installed where the backup generator is located so that the generator can provide temporary electrical energy in case the backup power supply fails. This board constantly monitors the power of the electrical network. Surges or serious power quality problems that may precede an outage trigger the generator's start command.

## ADJUSTABLE PARAMETERS

» Grid Voltage Min. Limit	» Grid Voltage Max. Limit	» Generator Voltage Min. Limit	» Generator Voltage Max. Limit	» Frequency Min. Limit	» Frequency Max. Limit
» Ignition Number	» First Time for Ignition	» Last Time for Ignition	» Time for Ignition	» Stop Time	» Grid Delay Time
» Cooling Time	» Grid Contactor Duration	» Generator Contactor Duration	» Relay and Oil Input Selection	» Generator Working Delay	» Maximum Engine Run Time



# GENERATOR MODELS

MODEL	G3M	G5M	G6M	G15M	G17M	G20M
<b>GENERATOR TYPE</b>	Mobil Generator	Mobil Generator	Mobil Generator	Mobil Generator	Platform/ Ray	H Class
<b>STAND BY POWER</b>	3 KVA	5 KVA	6 KVA	15 KVA	17 KVA	20 KVA
<b>CONTINUOUS POWER</b>	2,5 KVA	4 KVA	5 KVA	12,5 KVA	12,5 KVA	16 KVA
<b>FREQUENCY</b>	50 Hz	50 Hz	50 Hz	50 Hz	50 Hz	50 Hz
<b>COOLING SYSTEM</b>	Water Cooling System	Water Cooling System	Water Cooling System	Water Cooling System	Water Cooling System	Water Cooling System
<b>VOLTAGE PHASE NUMBER</b>	1	1	1	1	1	3
<b>CONNECTION TYPE</b>	RS422 - TCP	RS422 - TCP	RS422 - TCP	RS422 - TCP	RS422 - TCP / IP-Canbus	RS422 - TCP / IP-Canbus
<b>SOUND LEVEL</b>	75 Db in 7 Meters	95 Db in 7 Meters	75 Db in 7 Meters	75 Db in 7 Meters	7 Metrede 70 dB	75 Db in 7 Meters
<b>WEIGHT</b>	156 KG	230 KG	170 KG	700 KG	1000 KG	900 KG
<b>OPERATING TEMPERATURE</b>	-32 / +55 °C	-32 / +55 °C	-32 / +55 °C	-32 / +55 °C	-32 / +55 °C	-32 / +55 °C
<b>STORAGE TEMPERATURE</b>	-40 / +60 °C	-40 / +60 °C	-40 / +60 °C	-40 / +60 °C	-40 / +60 °C	-40 / +60 °C
<b>FUEL TYPE</b>	Diesel / 3 LT	Diesel / 3 LT	Diesel / 3 LT	Diesel / 5 LT	Diesel / 8,6 LT	Diesel / 5 LT
<b>BATTERY CAPABILITY</b>	40 AH	40 AH	38 AH @12V	95 AH @ 12 v	95 AH @12V 2 PCS	95 AH @12V 2 PCS
<b>ENGINE</b>	Kubota	Kubota	Kubota	Kubota	Kubota	Kubota
<b>MODEL</b>	Z482	Z482	Z482	D1105T	D1105T	D1105T

# TECHNICAL MATRIX

G22D	G25DM	G25M	G25MC	G255	G28M	G80S
Platform / Dual	Platform/ Ray	Platform/ Ray	Platform Generator	Platform Generator	Platform Generator	Platform Generator
22,5 KVA	25 KVA	25 KVA	25KVA	25 KVA	28,8 KVA	80 KVA
18,5 KVA	20 KVA	20 KVA	22,5 KVA	22,5 KVA	22,5 KVA	62,5 KVA
50 Hz	50 Hz	50 Hz	50 Hz	50 Hz	50 Hz	50 Hz
Water Cooling System	Water Cooling System	Water Cooling System	Water Cooling System	Water Cooling System	Water Cooling System	Water Cooling System
3	3	3	3	3	3	3
RS422 – TCP / IP Canbus	RS422 – TCP / IP-Canbus	RS422 – TCP / IP-Canbus	RS422 – TCP / IP-Canbus	RS422 – TCP / IP-Canbus	RS422 – TCP / IP-Canbus	RS422 – TCP / IP-Canbus
75 Db in 7 Meters	64 Db in 7 Meters	70 Db in 7 Meters	75 Db in 7 Meters	75 Db in 7 Meters	75 Db in 7 Meters	64 Db in 7 Meters
1000 KG	800 KG	860 KG	1000 KG	1000 KG	1000 KG	2000 KG
-32 / +55 °C	-32 / +55 °C	-32 / +55 °C	-32 / +55 °C	-32 / +55 °C	-32 / +55 °C	-32 / +55 °C
-40 / +60 °C	-40 / +60 °C	-40 / +60 °C	-40 / +60 °C	-40 / +60 °C	-40 / +60 °C	-40 / +60 °C
Diesel / 8,6 LT /H	Diesel / 6,1 LT /H	Diesel / 7,8 LT /H	Diesel / 8,6 LT /H	Diesel / 8,6 LT /H	Diesel / 8,6 LT /H	Diesel / 23 LT /H
95 AH @12V 2 PCS	95 AH @12V 2 PCS	95 AH @12V 2 PCS	120 AH @12 v	120 AH @12 v	120 AH @12 v	120 AH @12V 2 PCS
Kubota	Perkins	Perkins	Kubota	Kubota	Kubota	Perkins
404D22G	404D-22TG	V1505T	V1505T	V1505T	V1505T	44TAG2

# AUXILIARY POWER UNIT (APU)

» APU (Auxiliary Power Units) systems are systems that provide energy for the active operation of the systems on the vehicle when the vehicle ignition is turned off, and provide the desired energy to the vehicle for air conditioning system.

» These systems, which are integrated into armoured vehicles, have the ability to provide power to carry out all activities on the vehicle without the vehicle engine running.

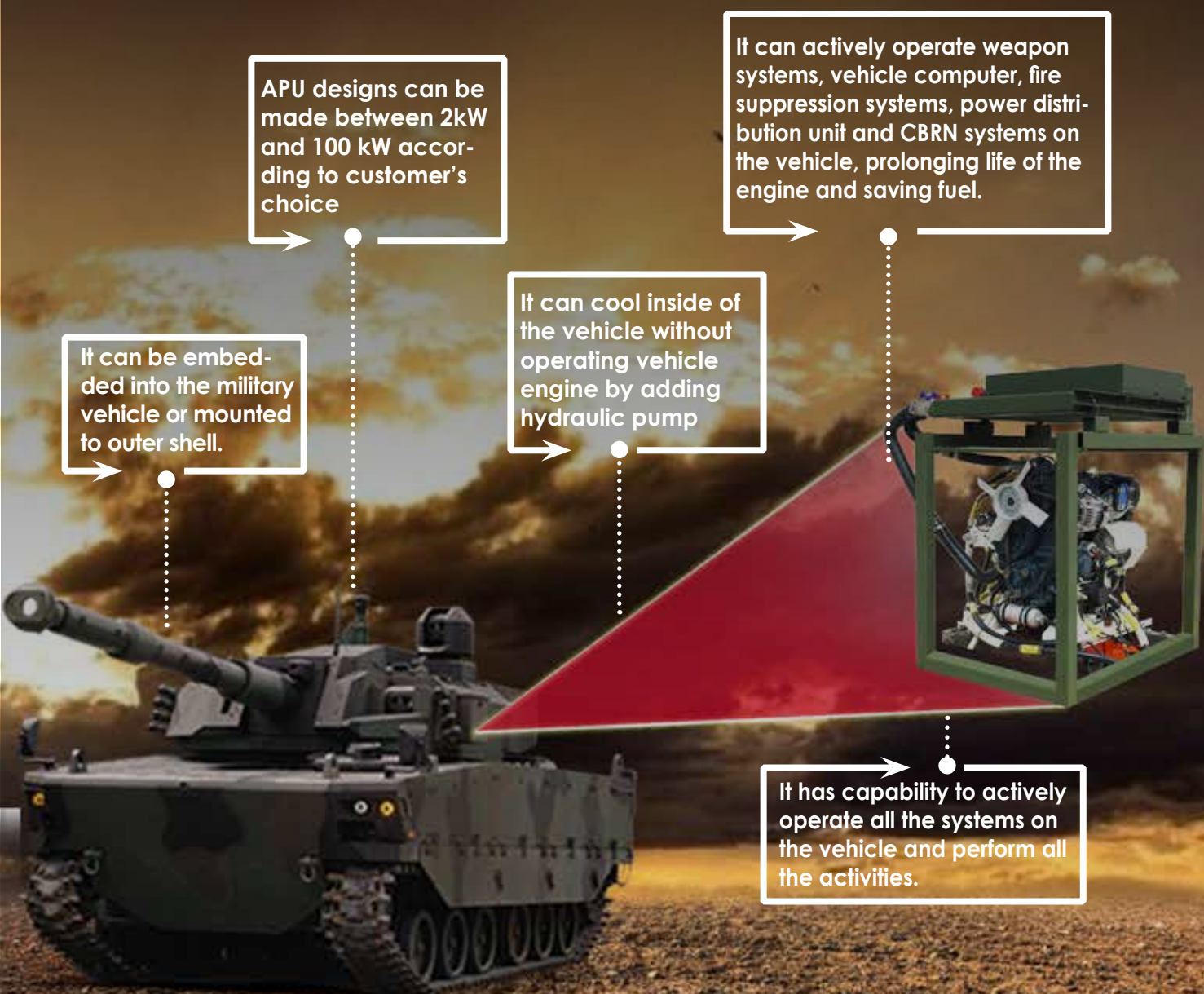

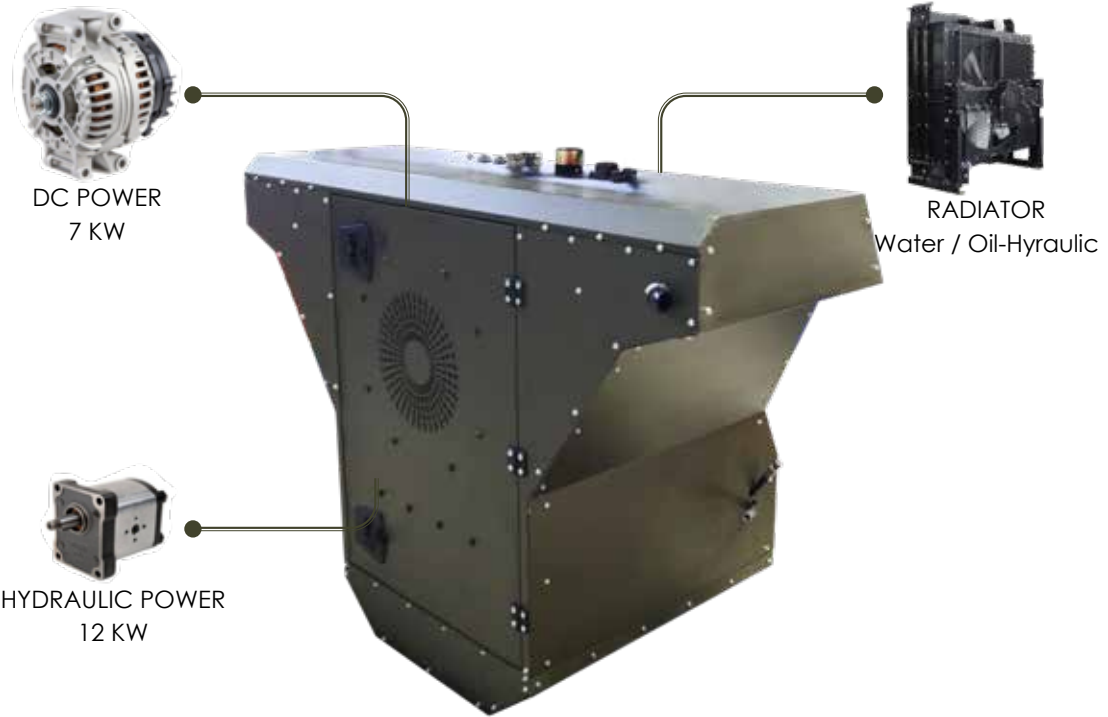







# APU - A22K

## APU SPECIFICATIONS

 <u>MAXIMUM AMPER</u> 330 A	 <u>OUTPUT VOLTAGE</u> 28 VDC
 <u>CONTINUOUS POWER</u> 20 KVA	 <u>STORAGE TEMPERATURE</u> -40 / +50 °C
 <u>NOMINAL OUTPUT POWER</u> 20,3 KVA	 <u>SOUND LEVEL</u> 85 Db in 7 Meters
 <u>FUEL CAPABILITY</u> External tank	 <u>WEIGHT</u> 450 KG ±5
 <u>COOLING SYSTEM</u> Water Cooling System	 <u>OPERATING TEMPERATURE</u> -32 / +55 °C

## GENERAL SPECIFICATIONS

 <u>COMPRESSOR</u> 7 KW
 <u>VOLTAGE</u> 28 VDC
 <u>VOLTAGE SENSITIVITY</u> 28 ± 0,3
 <u>FUEL TYPE / CAPABILITY</u> Diesel / 10 Liter
 <u>ENGINE TYPE</u> Kubota
 <u>DIMENSIONS ( L x W x H )</u> 1168x1595x860 ±5 mm



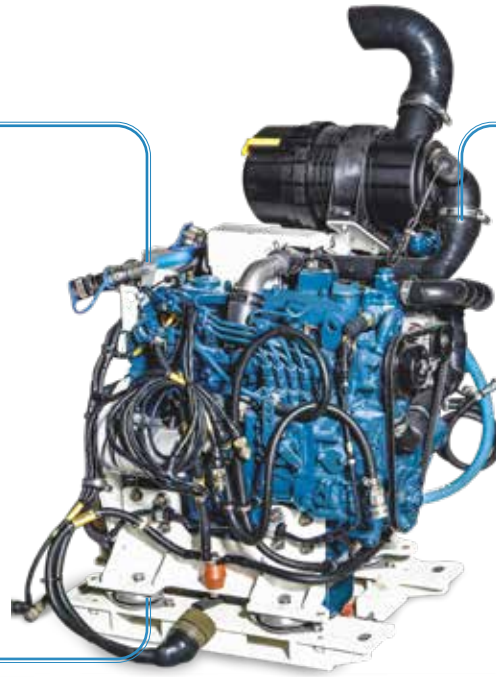
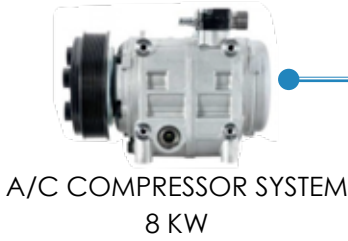

# APU - A20K

## APU SPECIFICATIONS

 MAXIMUM AMPER  
160 A

 OUTPUT VOLTAGE  
28 VDC

 CONTINUOUS POWER  
20 KVA

 STORAGE TEMPERATURE  
-40 / +60 °C

 NOMINAL OUTPUT POWER  
20,3 KVA

 SOUND LEVEL  
85 Db in 7 Meters

 FUEL CAPABILITY  
External tank

 WEIGHT  
350 KG ±5

 COOLING SYSTEM  
Water Cooling System

 OPERATING TEMPERATURE  
-32 / +55 °C

## GENERAL SPECIFICATIONS

 COMPRESSOR  
8 KW

 VOLTAGE  
28,5 VDC

 VOLTAGE SENSITIVITY  
%15 ± 0,3

 FUEL TYPE / CAPABILITY  
Diesel / 10 LT

 ENGINE TYPE  
Perkins

 DIMENSIONS ( L x W x H )  
3190x1190x875 ±5 mm



A/C COMPRESSOR SYSTEM  
8 KW



# APU - A151K

## APU SPECIFICATIONS

 MAXIMUM AMPER  
300 A

 OUTPUT VOLTAGE  
28 VDC

 CONTINUOUS POWER  
18 KVA

 STORAGE TEMPERATURE  
-40 / +50 °C

 NOMINAL OUTPUT POWER  
22,5 KVA

 SOUND LEVEL  
80 Db in 7 Meters

 FUEL CAPABILITY  
External tank

 WEIGHT  
450 KG ±5

 COOLING SYSTEM  
Water Cooling System

 OPERATING TEMPERATURE  
-32 / +55 °C

## GENERAL SPECIFICATIONS

 COMPRESSOR  
8 KW

 VOLTAGE  
28 VDC

 VOLTAGE SENSITIVITY  
28 ± 0,3

 FUEL TYPE / CAPABILITY  
Diesel / 6,3 Liter

 ENGINE TYPE  
Perkins

 DIMENSIONS( L x W x H)  
675x1754x947 ±5 mm

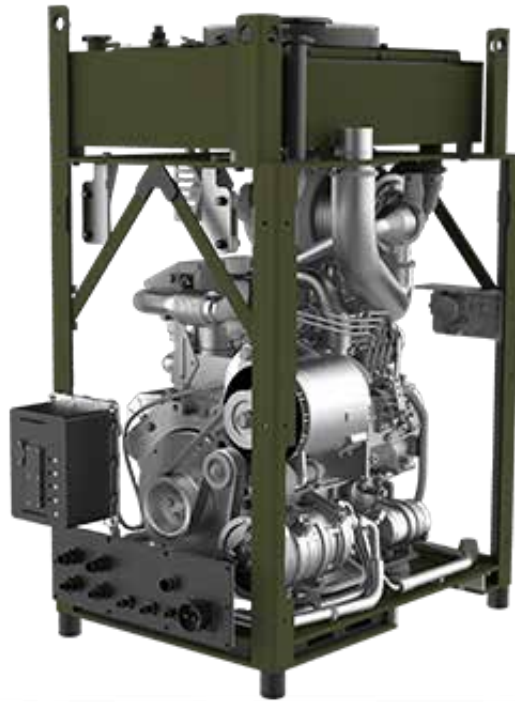

# APU - A12011

## APU SPECIFICATIONS

 MAXIMUM AMPER  
200 A

 OUTPUT VOLTAGE  
28 VDC

 CONTINUOUS POWER  
18 KVA

 STORAGE TEMPERATURE  
-40 / +60 °C

 NOMINAL OUTPUT POWER  
22,5 KVA

 SOUND LEVEL  
75 Db in 7 Meters

 FUEL CAPABILITY  
External tank

 WEIGHT  
114 KG ±5

 COOLING SYSTEM  
Water Cooling System

 OPERATING TEMPERATURE  
-32 / +55 °C

## GENERAL SPECIFICATIONS

 COMPRESSOR  
2x8 KW

 VOLTAGE  
28 VDC

 VOLTAGE SENSITIVITY  
± 2,5

 FUEL TYPE / CAPABILITY  
Diesel / External tank

 ENGINE TYPE  
KUBOTA

 DIMENSIONS ( L x W x H)  
565x433x621 ±5 mm



# APU - A21822

## APU SPECIFICATIONS

 MAXIMUM AMPER  
330 A

 CONTINUOUS POWER  
15 KVA

 NOMINAL OUTPUT POWER  
12,4 KVA

 FUEL CAPABILITY  
External tank

 COOLING SYSTEM  
Water Cooling System

 OUTPUT VOLTAGE  
28 VDC

 STORAGE TEMPERATURE  
-40 / +63 °C

 SOUND LEVEL  
69 Db in 7 Meters

 WEIGHT  
163 KG ±5

 OPERATING TEMPERATURE  
-32 / +55 °C

## GENERAL SPECIFICATIONS

 COMPRESSOR  
Optional

 VOLTAGE  
28 VDC

 VOLTAGE SENSITIVITY  
± 2,5

 FUEL TYPE / CAPABILITY  
Diesel / External tank

 ENGINE TYPE  
KUBOTA

 DIMENSIONS( L x W x H)  
569x536x542 ±5 mm





# APU - A1621K

## APU SPECIFICATIONS

 MAXIMUM AMPER  
240 A

 OUTPUT VOLTAGE  
28 VDC

 CONTINUOUS POWER  
11,6 KVA

 STORAGE TEMPERATURE  
-40 / +60 °C

 NOMINAL OUTPUT POWER  
16 KVA

 SOUND LEVEL  
85 Db in 7 Meters

 FUEL CAPABILITY  
Diesel / External tank

 WEIGHT  
240 KG ±5

 COOLING SYSTEM  
Water Cooling System

 OPERATING TEMPERATURE  
-32 / +49 °C

## GENERAL SPECIFICATIONS

 COMPRESSOR  
Optional

 VOLTAGE  
28 VDC

 VOLTAGE SENSITIVITY  
28 ± 0,3

 FUEL TYPE / CAPABILITY  
Diesel / External tank





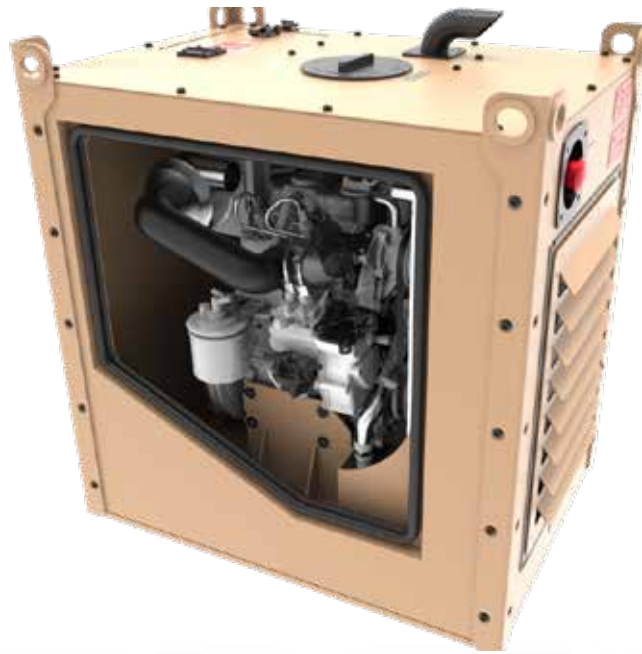





 ENGINE TYPE  
Horizontal

 DIMENSIONS ( L x W x H )  
1420x623x420 ±5 mm









## APU - A141F

### APU SPECIFICATIONS

 <u>MAXIMUM AMPER</u> 160 A	 <u>OUTPUT VOLTAGE</u> 28 VDC
 <u>CONTINUOUS POWER</u> 4,2 KVA	 <u>STORAGE TEMPERATURE</u> -40 / +55 °C
 <u>NOMINAL OUTPUT POWER</u> 7 KVA	 <u>SOUND LEVEL</u> 85 Db in 7 Meters
 <u>FUEL CAPABILITY</u> External tank	 <u>WEIGHT</u> 150 KG ±5
 <u>COOLING SYSTEM</u> Water Cooling System	 <u>OPERATING TEMPERATURE</u> -32 / +49 °C

### GENERAL SPECIFICATIONS

 <u>COMPRESSOR</u> Optionel
 <u>VOLTAGE</u> 28,5 VDC
 <u>VOLTAGE SENSITIVITY</u> 28,5 ± 0,3
 <u>FUEL TYPE / CAPABILITY</u> Diesel / 10 Litre
 <u>ENGINE TYPE</u> Kubota
 <u>DIMENSIONS ( L x W x H )</u> 530x564x660 ±5 mm













A/C COMPRESSOR SYSTEM  
8 KW









# APU - A20F

## APU SPECIFICATIONS

-  MAXIMUM AMPER  
190 A
-  CONTINUOUS POWER  
20 KVA
-  NOMINAL OUTPUT POWER  
33 KVA
-  FUEL CAPABILITY  
External tank
-  COOLING SYSTEM  
Water Cooling System
-  OUTPUT VOLTAGE  
28 VDC
-  STORAGE TEMPERATURE  
-40 / +55 °C
-  SOUND LEVEL  
80 Db in 7 Meters
-  WEIGHT  
280 KG ±5
-  OPERATING TEMPERATURE  
-32 / +49 °C

## GENERAL SPECIFICATIONS

-  COMPRESSOR  
8 KW
-  VOLTAGE  
24 VDC
-  VOLTAGE SENSITIVITY  
28 ± 0,3
-  FUEL TYPE / CAPABILITY  
Diesel / 6,3 LT
-  ENGINE TYPE  
Kubota
-  DIMENSIONS ( L x W x H )  
672x632x1104 ±5 mm

# NL-1628 AUXILIARY POWER UNIT CONTROL UNIT



## ERROR LEDS

• Engine High Temperature
• Low Oil Pressure
• Cabin Water Level High
• Air Filter Clogged
• Radiator Water Level Low
• Maintenance Cover Open

- It is located near APU so that the user can intervene easily in case of maintenance.
- Existing errors on APU can be observed.
- There are buttons to directly intervene when there is a problem during automatic start of APU.
- It is designed as per IP67 Standards. Besides, it enables to reach last 500 detailed logs thanks to diagnostic.
- It is conformant to MIL-STD-810G and MIL-STD-461E/F standards.

## TECHNICAL SPECIFICATIONS

Dimensions (WidthxLengthxHeight)	140x213x160 ±5 mm
Weight	3,1 kg ±0.1
Communication Protocol	CANBUS J1939
Operating Voltage	24 VDC



## NL-1628 BUTTON SPECIFICATIONS



1.	A/C CLUTCH: The air conditioning system cannot be started while the corresponding LED is on.	12.	WATER IN FUEL FILTER: The corresponding LED lights when the water level in the fuel water filter increases.
2.	HYDRAULIC SOLENOID: The corresponding LED light comes on when the hydraulic solenoid is activated.	13.	EMERGENCY STOP: When pressed, the emergency button is activated.
3.	HYDRAULIC FAN PWM : Hydraulic LED speed decreases as the fan speed increases.	14.	MANUAL ACTUATOR: The Actuator operates as long as it is kept pressed.
4.	RADIATOR FAN PWM : The corresponding LED light level decreases while radiator fan speed increases.	15.	MANUAL FUEL PUMP: The Fuel Pump operates as long as it is kept pressed.
5.	EMERGENCY STOP : The corresponding LED lights if any of the emergency stop buttons are active.	16.	MANUAL START: The Starter Motor operates as long as it kept pressed.
6.	HIGH ENGINE COOLANT TEMP : The corresponding LED lights when the engine water temperature is high.	17.	MANUAL GLOW: The Glow operates as long as it kept pressed.
7.	LOW OIL PRESSURE: The corresponding LED lights when the engine oil pressure is low.	18.	ACT: The fuse of Actuator.
8.	HIGH CABIN WATER LEVEL: The corresponding LED lights when there is no water in the cab. If there is water, it goes out.	19.	FUEL PUMP: The fuse of Fuel Pump.
9.	AIR FILTER CLOGGING: The corresponding LED is lights if the air filter is clogged.	20.	STARTER ENGINE: The fuse of Starter Engine.
10.	LOW RADIATOR WATER LEVEL : The corresponding LED lights when there is no water in the radiator. If there is water, it goes out.	21.	GLOW: The fuse of Glow.
11.	FSS ALARM: The corresponding LED is lights when the event of an alarm in the APU engine compartment.	22.	DIAGNOSTIC: Software installation socket.

# A20-F REMOTE COMMAND CONTROL UNIT



- It is used to remote control APU.
- Being located by vehicle driver, it enables to reach all the data on APU with the information screen on it.
- Control unit enables to activate-cancel APU system, to activate-cancel air conditioning system.
- It is designed as per IP67 Standards.
- It is conformant to MIL-STD-810G and MIL-STD-461E/F standards.

## TECHNICAL SPECIFICATIONS

Dimensions (WidthxLengthxHeight)	45x155x85 ±5 mm
Weight	0,48 kg ±0.1
Communication Protocol	CANBUS J1939
Operating Voltage	24 VDC

## BUTTON SPECIFICATIONS



1.	ON / OFF: APU on / off button.	6.	EMERGENCY STOP
2.	AIR CONDITIONING ON/OFF	7.	APU ON: LED indicators for states
3.	CIT: CIT test is performed when the relevant button is pressed.	8.	AIR CONDITIONER ON
4.	CANCEL: Pressing the BIT button for 5 seconds will cancel this operation.	9.	CIT : CIT led turns red when the test fails.
5.	UP DIRECT MENU BUTTON-DOWN MENU BUTTON	10.	FAULT : LED turns off when cancel button is pressed.

# EQUIPMENT CONTAINER SHELTER

## GENERAL SPECIFICATIONS

- The Equipment Shelter has a structure and insulation that can protect all active equipment under all conditions during operation.
- Fire resistant polyurethane foam is used for thermal insulation between the surfaces of the Equipment Shelter (including the ceiling).
- The Equipment Shelter subunits covers/doors are supported by RF gaskets.
- The Equipment Shelter has one PTZ camera that can be remotely controlled and can operate in all weather conditions.
- The Equipment Shelter Cabinet (19 inches) is built to withstand vibration.
- The Equipment Shelter has a portable structure.
- Equipment Shelter racks, attachment points and fasteners are made of rustproof and maintenance-free material.
- The Equipment Shelter is protected against lightning by Franklin rod.
- Equipment Conservation is in compliance with Ministry of Energy and Natural Resources – Regulation on Grounding in Electrical Installations / Part 5.
- The Equipment Shelter doors can remain stable in the open position in a wind of at least 40 knots.
- The Equipment Shelter is equipped with military-grade connectors.
- The Equipment Shelter is equipped with air conditioning system with 800 BTU capacity.



## APPLIED TESTS

MIL-STD-810G - 500.5	Low Pressure/ altitude
MIL-STD-810G - 501.5	High temperature
MIL-STD-810G - 502.5	Low Temperature
MIL-STD-810G - 514.6	Vibration
MIL-STD-810G - 521.3	Icing
MIL-STD-810G - 507.5	Moisture
MIL-STD-810G - 506.5	Rain
MIL-STD-810G - 516.6	Shock
MIL-STD-810G - 505.5	Daylight Application

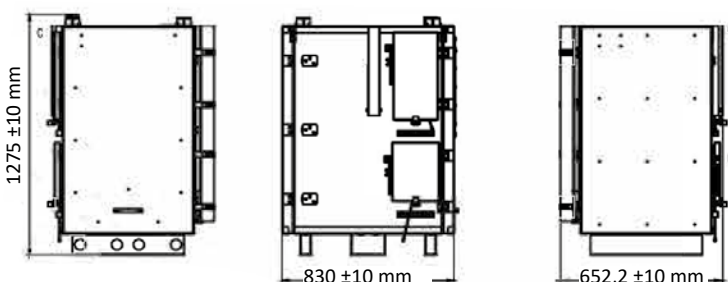



# POWER DISTRIBUTION UNITS

Power distribution units can automatically distribute AC and DC power provided from 2-10 different sources to 50 different units.

On PDU system with 2 digital screens, it provides the information such as operation hour, battery charge status, power selection to the user.

Power Distribution Units can be specially designed, produced, tested according to requested needs, dimensions and capacities by Nero Industry.

It can automatically distribute AC and DC power to 50 different units.

On the unit where there are separate fuses for each unit whose power requirement is supplied, it is ensured that power of other units is not cut even if a unit blows the fuse.

Power Distribution Units are military products which have successfully passed high temperature, low temperature, high humidity, shock-vibration and EMI/EMC tests as per MIL STD 810H, MIL STD 461F and MIL STD 1275E standards.



# GDU336 POWER DISTRIBUTION UNIT

## GENERAL SPECIFICATIONS

- Information Screen
- PSU On / Off Switch and Led
- Active Section Selection Switch and Leds
- Generator Operating/Stop Button
- Emergency Stop Button
- Emergency Stop LED Indicator
- Alarm Reset Button
- Generator LED Indicator
- PTO Alternator LED Indicator
- Panel Test Button
- Operation Hour Indicator
- System Battery Led Indicator (Green)
- Vehicle Battery Led Indicator (Green)
- Vehicle Battery Charge Status Led Indicator (Red)
- System Battery Charge Status Led Indicator (Red)
- BIT Status Inquiry Button
- On/Off Buttons (In number of Sub-systems)
- On/Off All Button are present.



## TECHNICAL SPECIFICATIONS

COMMUNICATION INFRASTRUCTURE	RS422, RS485, CANBUS
DIMENSION (LXWXH)	430x117x260 mm
WEIGHT	5 KG
OPERATING TEMPERATURE	-32 / +55°C
STORAGE TEMPERATURE	-40 / +60°C

## STANDARDS

MIL-C-38999	Military Connector
MIL-DTL-27500	Special Purpose, Electrical Shielded and Unshielded Cables
MIL-STD-461E	Military Electromagnetic Compatibility
MIL-STD-810G	Military Environmental Conditions
MIL-STD-1275E	28 VDC Counter Characteristic
STANAG 4135AC	AC Current Characteristic



# PSU336 POWER DISTRIBUTION / SWITCHING UNIT



## GENERAL SPECIFICATIONS

- Information Screen
- PSU On / Off Switch and Led
- Active Section Selection Switch and Leds
- Generator Operating/Stop Button
- Emergency Stop Button
- Emergency Stop LED Indicator
- Alarm Reset Button
- Generator LED Indicator
- PTO Alternator LED Indicator
- Panel Test Button
- Operation Hour Indicator
- System Battery Led Indicator (Green)
- Vehicle Battery Led Indicator (Green)
- Vehicle Battery Charge Status Led Indicator (Red)
- System Battery Charge Status Led Indicator (Red)
- BIT Status Inquiry Button
- On/Off Buttons (In number of Sub-systems)
- On/Off All Button are present.

## STANDARDS

MIL-C-38999	Military Connector
MIL-DTL-27500	Special Purpose, Electrical Shielded and Unshielded Cables
MIL-STD-461E	Military Electromagnetic Compatibility
MIL-STD-810G	Military Environmental Conditions
MIL-STD-1275E	28 VDC Counter Characteristic
STANAG 4135AC	AC Current Characteristic

## TECHNICAL SPECIFICATIONS

COMMUNICATION INFRASTRUCTURE	RS422, RS485, CANBUS
DIMENSION (LXWXH)	430x117x260 MM
WEIGHT	5 KG
OPERATING TEMPERATURE	-32 / +55°C
STORAGE TEMPERATURE	-40 / +60°C

# PDU-80 POWER DISTRIBUTION UNIT



## GENERAL SPECIFICATIONS

- AC/DC output control
- Remote control with computer software
- Ability to measure temperature and automatically adjust the environment to the desired temperature,
- Ability to control all functions over Ethernet
- Instantly transferring UPS faults and statuses to the user with the Power Distribution Unit,
- Ability to manually power the equipment to be fed by disabling the PDU from the software,
- Power Distribution Unit can manage 3 AC Inputs (UPS, City Network, Generator),
- Being able to automatically charge the UPS batteries when the generator or grid are on.
- With Toggle-type circuit breakers, it provides over-current, short-circuit protections.
- Ability to switch 10 AC/DC outputs,
- It has the ability to read DC, AC current, Voltage and Frequency values and transfer them to the user.

## FAILURE AND WARNING MODES

- AC High,
- AC Low,
- AC Reverse,
- DC High,
- DC Low,
- Temperature High,
- It has Temperature Low warning modes.

## TECHNICAL SPECIFICATIONS

COMMUNICATION INFRASTRUCTURE	RS422, RS485, CANBUS
DIMENSION (LXWXH)	482x176x630 MM
WEIGHT	3 KG
OPERATING TEMPERATURE	-32 / +55 °C
STORAGE TEMPERATURE	-40 / +60 °C

## STANDARDS

MIL-C-38999	Military Connector
MIL-DTL-27500	Special Purpose, Electrical Shielded and Unshielded Cables
MIL-STD-461E	Military Electromagnetic Compatibility
MIL-STD-810G	Military Environmental Conditions
MIL-STD-1275E	28 VDC Counter Characteristic
STANAG 4135AC	AC Current Characteristic

# PDU-40 POWER DISTRIBUTION UNIT



## FAILURE AND WARNING MODES

- AC High,
- AC Low,
- AC Reverse,
- DC High,
- DC Low,
- Temperature High,
- It has Temperature Low warning modes.

## GENERAL SPECIFICATIONS

- Ability to meet AC/DC power needs,
- Remote control with computer software and ethernet,
- Having Can-Bus, Ethernet and RS-232 communication infrastructures,
- Easily transferring errors and situations to the user thanks to its digital screen,
- Ability to automatically control UPS, Generator and Grid power inputs,
- Being protected against over current and short circuit,
- Having an audible warning feature,
- Being able to control the air conditioning unit with the data received from automatic sensors,
- Ability to automatically adjust the temperature inside the shelter,
- Being able to carry out the instructions for turning on and off the shelter interior lighting system,
- It has the features of Generator monitoring, Generator on and off features.

## STANDARDS

MIL-C-38999	Military Connector
MIL-DTL-27500	Special Purpose, Electrical Shielded and Unshielded Cables
MIL-STD-461E	Military Electromagnetic Compatibility
MIL-STD-810G	Military Environmental Conditions
MIL-STD-1275E	28 VDC Counter Characteristic
STANAG 4135AC	AC Current Characteristic

## TECHNICAL SPECIFICATIONS

COMMUNICATION INFRASTRUCTURE	RS422, RS485, CANBUS
DIMENSION (LXWXH)	482x176x630 MM
WEIGHT	3 KG
OPERATING TEMPERATURE	-32 / +55 °C
STORAGE TEMPERATURE	-40 / +60 °C

# POWER DISTRIBUTION UNIT FOR ELECTRIC VEHICLE PDU-70

The PDU-70 is a power distribution unit developed by NERO Industries engineers in the scope of electrical vehicle application. The PDU-70 is a safe, intelligent and versatile power distribution unit in a compact form with configurable multiple power inputs and outputs.

The smart control unit provides easy integration for high voltage/high current system applications. As typical application fields; the PDU-70 is suitable for medium and heavy duty electric/hybrid vehicle power distribution and energy control. Some important features are as follows:



- High voltage power inputs for standard charging
- Isolated voltage reading at the high voltage inputs and outputs (up to 1000 VDC)
- High voltage safety interlock line (HVIL)
- Interlock line controlled high voltage battery relay control outputs
- Earth insulation level measurement
- Secondary passive high voltage DC bus energy sinking
- Active high voltage DC bus energy sinking (Through PTC Thermistors)
- Pre-charge circuit at all high-voltage power outputs
- Fuse protection at high voltage outputs
- Overvoltage, undervoltage, overcurrent and over-temperature protection
- Low power mode

## CAN COMMUNICATION

- PDU-70 uses SAE J-1939 standard CAN protocol in order to communicate with the electrical control unit (ECU).
- 250kbit/s bit rate is chosen in order to provide reliable operation.
- The cyclic status messages are transmitted by the PDU-70 in every 100 ms and the cyclic command message is expected from the ECU in every 100 ms. If the command message is not received by the
- PDU-70 for 400 ms, the emergency output is asserted (logic high) in order to indicate fault but the operational state of the PDU-70 stays the same in order to give the ECU to control the whole system.
- For the sake of the operation, the PDU-70 should be taken into low power mode as soon as possible.
- The details of the CAN messages can be found in log file.

## RS422 COMMUNICATION

- PDU-70 uses RS422 communication in order to send status messages to the diagnostic/record device in the system.
- The PDU-70 does not receive any message through RS422, hence no operational change can be performed. By using RS422 communication, a secondary check to CAN communication can be provided.

## TRACTION VOLTAGE POWER DISTRIBUTION UNIT FOR ELECTRIC VEHICLES TRACTION AND AUXILIARY HIGH VOLTAGE SYSTEMS INCLUDING:

- Active unit include traction voltage contactors and contactor controls
- with Voltage and current measurement units.
- Pre-charging circuit to balance voltage levels before and after contactors
- Service charging circuit with contactor switching
- High voltage circuit insulation resistance measurement & monitoring
- Fuse protection for high and low current component output
- Hazardous voltage interlock loop (HVIL)



### TECHNICAL SPECIFICATIONS

» Operating Temperature Range	-40°C / +70°C
» Storage Temperature Range	-40°C / +85°C
» Protection Class	IP65
» Dimensions	714 x 505 x 165,2
» Weight	43 ± kg
» Cooling	Natural Airflow
» Operating Voltage Range	10 - 800 VDC
» Power Input	Battery Input 1 / 300 A
	Battery Input 2 / 300 A
	Battery Input 3 / 300 A
	Battery Input 4 / 300 A
	DC Charge Input / 400 A
» Power Output	Traction Inverter / 600 A
	PTO Inverter / 125 A
	On Board Charger / 50 A
	Air Compressor / 30 A
	Heater / 25 A
	DC-DC Converter / 25 A
	A/C Compressor / 30 A
» Current Peak	600 A
» Interlock Line ("HVIL") Current	Adjustable (Default: 35 mA)
» Interlock Line ("HVIL") Voltage	36 VDC
» Max Voltage Drop over HVIL Loop	Adjustable (Default: 12 VDC)
» Interfaces	CAN Bus SAE J-1939 RS422/485



# PTO ALTERNATORS

These are mechanical power products affixed to the spaces provided at truck gear boxes and used for transferring the power of vehicle engine to vehicle components as DC voltage by the help of alternator.

- Silent, light and noiseless.
- Small and compact power units for optimum space use in the vehicle.
- MIL-STD-461E/F and MIL-STD-810G certificates.
- 3 years guarantee.



## P40 ALTERNATOR

VOLTAGE PHASE NUMBER  
3

CONTINUOUS POWER  
10 KVA

TYPE  
Platform

WEIGHT  
70 KG ±5

CONNECTION TYPE  
CA3102E24-22SYB

FREQUENCY  
50 Hz

TEMPORARY VOLTAGE  
± %15

STORAGE TEMPERATURE  
-40 / +60 °C

OPERATING TEMPERATURE  
-32 / +55 °C

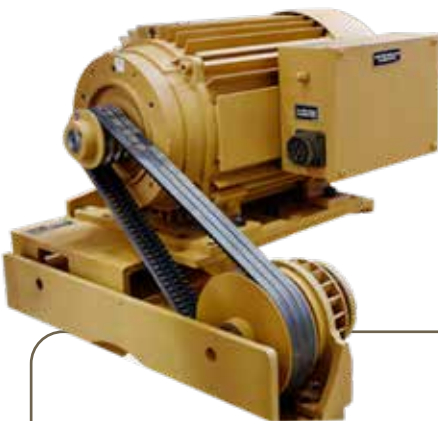

## P50 ALTERNATOR

VOLTAGE PHASE NUMBER  
3

CONTINUOUS POWER  
10 KVA

TYPE  
Platform

WEIGHT  
761 KG ±5

CONNECTION TYPE  
CA3102E24-22SYB

FREQUENCY  
50 Hz

STORAGE TEMPERATURE  
-40 / +60 °C

OPERATING TEMPERATURE  
-32 / +55 °C

# BATTERY MANAGEMENT SYSTEMS

Amper – Power Information, communication with the vehicle by CAN-BUS J-1839 protocol

10 – 500 Amper Current options

Aural and visual warning for high voltage, high battery heat, low voltage, overcurrent errors.

Simultaneous reading Amper – Power Information, Battery heat, Battery voltage values

It is tested for high temperature, low temperature, high humidity, shock-vibration and EMI/EMC as per MIL STD 810H, MIL STD 461F and MIL STD 1275E standards.



# RS3000 AC/DC CONVERTER



- It gives aural and visual warning in case of high current, short circuit, battery charging errors and redresser error.
- Redresser automatically stops when the engine operates.
- Redresser wire is portable and it has a minimum length of 5 meters.
- It has features of automatically adjusting charge current according to battery heat by battery heat measurement feature and stopping the operation whenever necessary, automatically switching off at the end of charging.
- It provides 80 Amper independent from vehicle engine on DC source mode.
- It simultaneously charges all the batteries on the vehicle with 5-7 Amper on battery charge mode.

## TECHNICAL SPECIFICATIONS

» Input Voltage Values	90-264V
» Input Current Values	16A max.
» Power Factor	0.95
» Max. Output Current Value	100A max.
» Number of Isolated Outputs	3 Pieces
» Operating Temperature	-20 + 70 °C
» Weight	14 kg
» Dye and Coating	It can be dyed and coated according to customer's choice.

# R28100 AC/DC CONVERTER



# RACK TYPE CONVERTER



## GENERAL SPECIFICATIONS

» Smart circuit provides three phase charge 6 bulk, absorption, float.	» Military type connection wires for optional use
» It can monitor battery system between 40-200 Amper value range with wide range of models.	» It has dimout mode feature.
» Multiple isolated outputs; show Amper meter total output current.	» Military type connectors
» The sensor for optional use, adjusts output voltage based on battery heat.	» 11 O db Buzzer
» Current classification prevents overloading.	» It has passed MIL STD 81 OG, MIL STD 127E, MIL STD 461 G Tests.
» Charge status is displayed on control unit.	» MTBF is 120.000 hours.
» It is conformant to EMI-EMC.	» It can be remote controlled thanks to CANBUS.
» It has 2-years guarantee.	» R28100 Analog and CANBUS Output
» Automatically stops when engine is started.	

# VEHICLE INTEGRATIONS

It is the operation where specific modifications and additions are made on the vehicle for the purpose of providing the power and cooling requirements of the military systems that are wanted to be integrated to the industrial vehicles. The power required for the systems to be integrated to 4x4 pick up, SUV and Minibuses such as intelligence equipment, jammer, signal jammer, etc. cannot be provided by the vehicles. Thanks to the R&D activities, Nero Industry places 50, 100 and 200 Amper additional alternators to the engine compartment of the vehicles. While these alternators are placed, engine volume, brand, model and first registration date of the vehicle are effective factors.

## GENERAL SPECIFICATIONS

»28V DC 50-500A DC ALTERNATOR
»2-15 kW ADDITIONAL AIR CONDITIONING SYSTEM CAPABILITY
»1-15 kW HYDRAULIC PUMP INTEGRATION
»4-12 kW A/C COMPRESSOR INTEGRATION
»MIL-STD-810G ENVIRONMENTAL TEST STANDARD
»MIL-STD-810G IMPERMEABILITY TEST

## MODIFICATION VEHICLES

### MERCEDES

VITO | 2009-2022

SPRINTER | 2009-2022

### VOLKSWAGEN

AMAROK | 2009-2022

### TOYOTA

HILUX | 2009-2022

### NISSAN

NAVARA | 2009-2022

### FORD

RANGER - F150 - F250 - F350 - F450 - F550 | 2009-2022

### GMC

YUKON | 2009-2022

### NISSAN

QASHQAI | 2009-2022

### FIAT

FREEMONT | 2009-2022

### TOYOTA

LAND CRUISER | 2009-2022





